

# DOCUMENTACIÓN TÉCNICA



Ref.: CGD23-I

Casita de estimulación temprana

UNE EN 1176-1:2018



Altura libre de caída: 0,44 m

Edad recomendada de uso: de 0 a 6 años

Estructura de acero inoxidable

Componentes plásticos: Polietileno de alta densidad con protección UV

Tornillería protegida con tapones de polipropileno

ALZADO

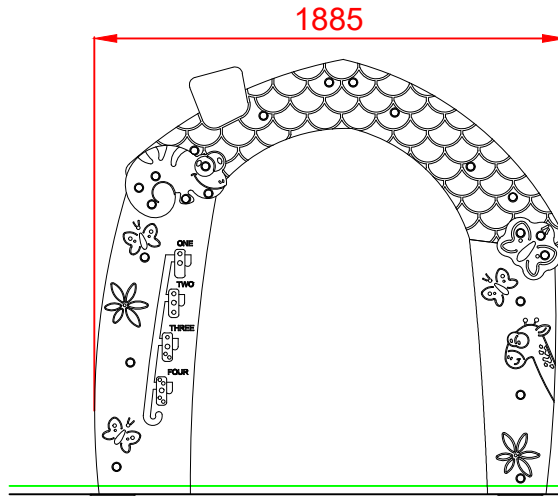

PERFIL IZQUIERDO

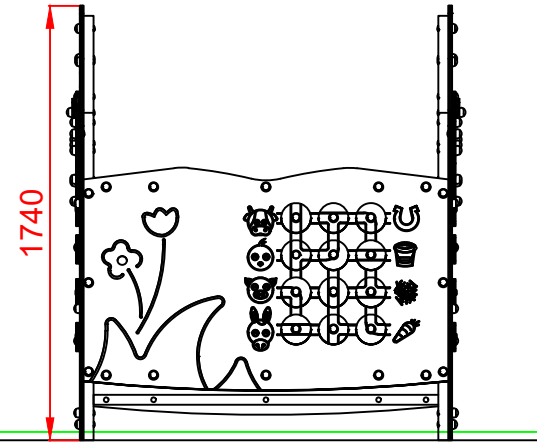

PLANTA

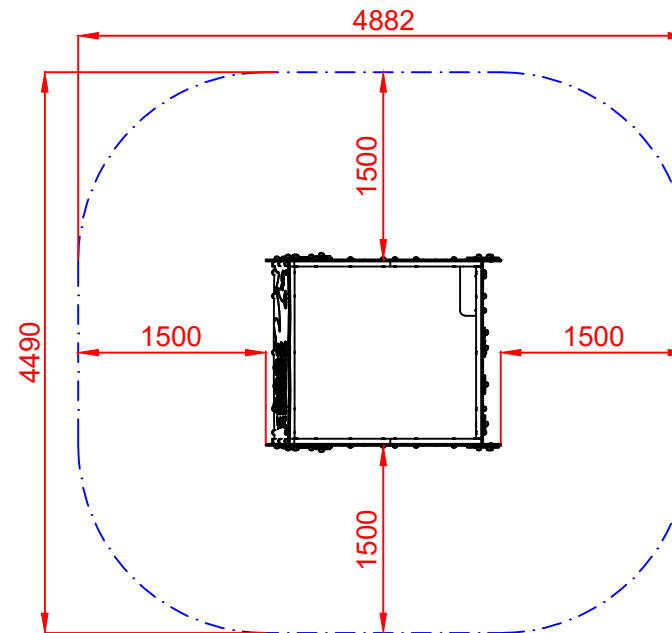
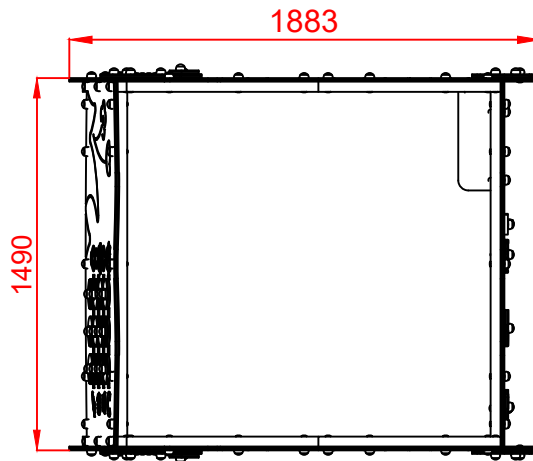

ÁREA DE SEGURIDAD  
Superficie= 20 m2  
E: 1/2

Dibujado		PLANO 1 VISTAS GENERALES	Ref:	CGD23-I
Revisado				
Aprobado				
Descripción:		CASITA DE ESTIMULACIÓN TEMPRANA	Escala:	Nº Hoja 2/3
			Fecha:	03/02/2022



DETALLES CIMENTACIÓN  
 ESQUEMA DE CIMENTACIÓN  
 EN ARENA

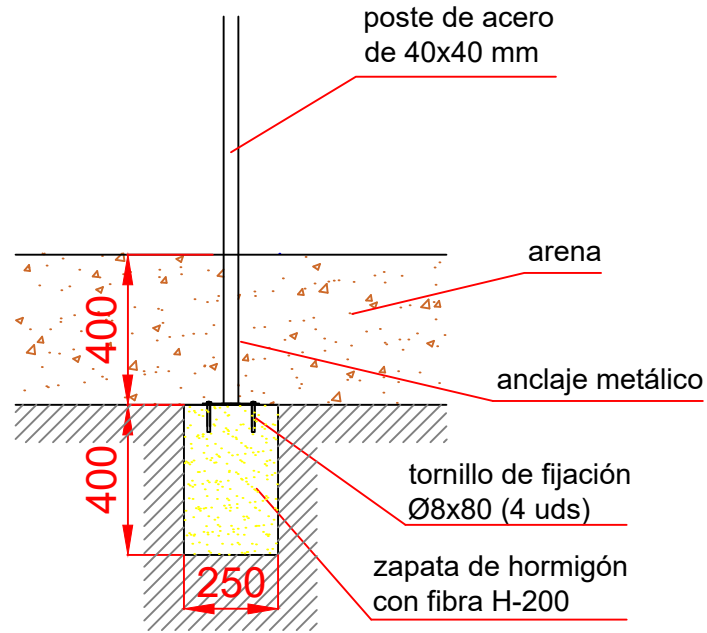

ESQUEMA DE CIMENTACIÓN  
 EN HORMIGÓN

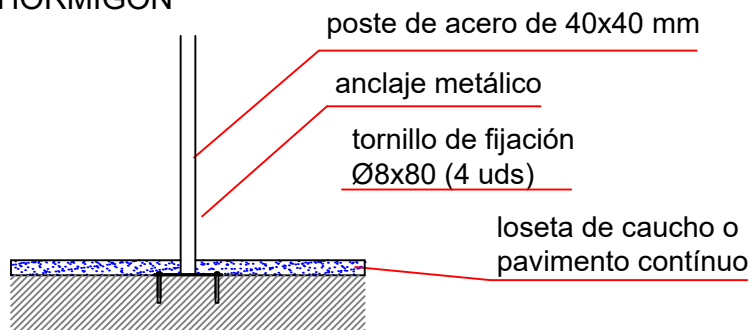

PLANTA CIMENTACIÓN

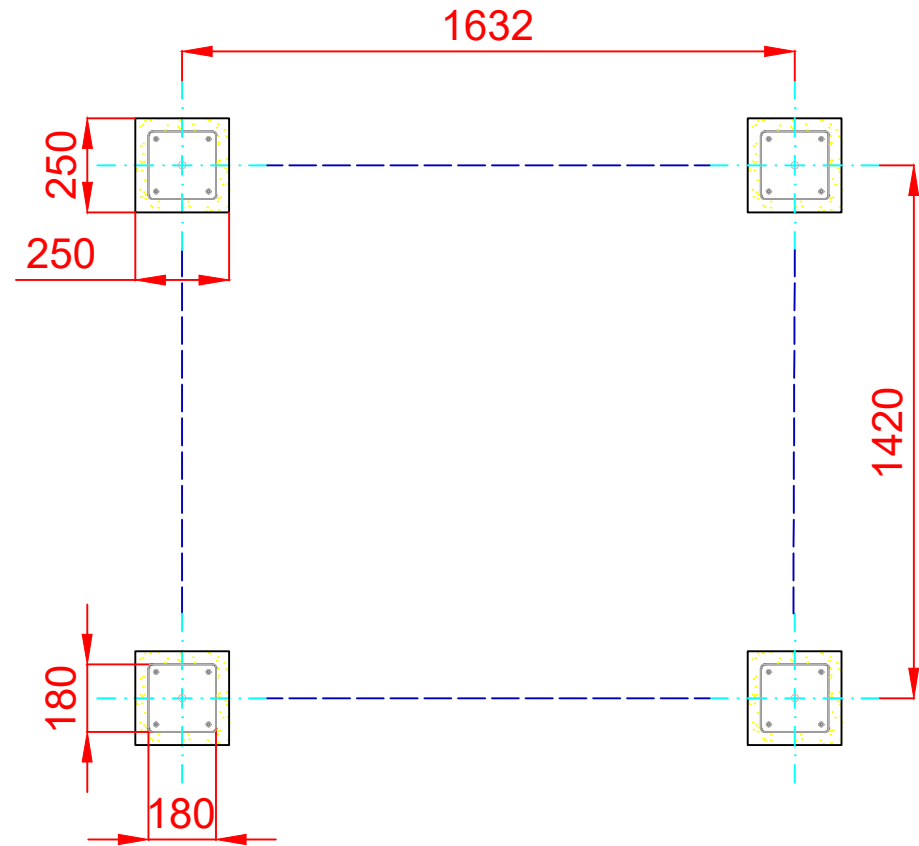

Dibujado		PLANO 2 CIMENTACIÓN Y ANCLAJES	Ref:	CGD23-I
Revisado				
Aprobado				
Descripción:		Escala:	Nº Hoja	
CASITA DE ESTIMULACIÓN TEMPRANA			3/3	
		Fecha:	02/02/2021	

